



Putzmeister



Efficient precast part production

The resource-optimised and incredibly flexible modular solution Autocor®

The future of precast part production – variable, inexpensive and worthwhile in every situation



The right solution concept for every job

Our solutions are economically viable in plants that process all kinds of pumpable concrete for medium and larger precast part elements. If an expansion is planned for older plants, our solutions can be easily retrofitted. For stationary formworks the Autocor® system can be fitted mobile and for movable formworks it can be installed in a stationary manner in a hall.

Filling from top or bottom

Formworks can be filled from the top using rotary distributors or stationary booms. Concrete flows from the bottom using delivery lines. With the continuous flow of concrete you increase the quality of the precast parts on the one hand, and save time and staff on the other hand with less reworking, e.g. levelling out or grinding, and shorter cleaning time thanks to the closed system.



Your benefits at a glance

- **Consistent concrete quality** thanks to continuous filling
- **Cleanliness** in the complete production process
- **Optimised** for all kinds of pumpable concrete
- **Flexibility** thanks to mobile or stationary systems and with filling from top and bottom
- **Economical production** even with different sized formwork elements



Less material usage and manpower – more output!

Concrete has a future. Because it impresses from an economic and ecological point of view and represents top quality and extreme durability at the same time. Optimal future prospects for your precast part production.

Want more? Even better prospects await you with state-of-the-art systems that offer maximum flexibility with minimal costs and personnel capacities.

What do you need? Clever solutions from a partner with decades of experience and process know-how in concrete.

PUTZMEISTER SOLUTIONS

MIN. MAX.

RESOURCE CONSUMPTION
STAFF DEPLOYMENT
CONCRETE RESIDUE

AUTOMATION
FLEXIBILITY
CAPACITY



The Putzmeister promise

The name Putzmeister stands for machines that enable you to work extremely productively and go beyond purely being competitive. To this end, we provide extraordinarily innovative technologies alongside top quality and excellent service. We are fully dedicated to supporting you both around the world and around the clock. Because every Putzmeister employee is aware of the fact that your products play a major role – today and in the future.

Your Putzmeister Team

The Autocor[®] system – flexible production with Putzmeister components



PUTZMEISTER AUTOCOR[®] MODULAR SYSTEM

Diversity with know-how – the choice is yours

Configured according to your range of products and services

For your individual solution we combine tried-and-tested Putzmeister components for pumping and distributing concrete. The operator controls the entire plant via radio remote control. You have the choice, thanks to the **Putzmeister Autocor[®] modular system!**

ergonic[®]
inside

The entire plant is operated with the Ergonic[®] control system.

Benefits of the Putzmeister modular system:

- **Almost unlimited flexibility** thanks to pipe connection
- **Simple handling** with few staff
- **Secure investment** thanks to low start-up costs and reliable expandability
- **Minimal amounts of concrete residue**
- **Simple cleaning**
- **Bridging large distances** and accessibility to several placement sites
- **Reduced pipeline wear**



YOUR INDIVIDUAL SOLUTION PACKAGE

Maximum productivity under your hall roof

Application-oriented
Autocor® systems –
best manufactured
by the concrete specialist!

You are experts when it comes to manufacturing high-quality concrete precast parts for architecture, traffic routes, infrastructure and lots more.

We specialise in providing efficient and long-term solutions for mixing, delivering and placing concrete with our machines and corresponding accessories.

And especially for you on this solid basis we develop systems for the automated production of precast parts.

TUNNELLING INDUSTRIAL CONSTRUCTION WIND POWER ROAD CONSTRUCTION HOUSING CONSTRUCTION BRIDGE CONSTRUCTION

Solution concept
with bucket conveyor

Even stationary is one step ahead.
Even an existing bucket conveyor can be integrated in the concept in order to supply a rotary distributor for filling formworks at the same height.

Combination example #2

- + H Attachable hopper
- + TI Rotor pump
- + TII Delivery line
- + E Rotary distributor RV



Solution concept with
fixed formworks

Fixed formwork, filling in all directions. With your individual machine from Putzmeister's modular system you can make concrete parts in different sizes, amounts and concrete quality efficiently and economically.

Combination example #1

- + H Buffer storage
- + TI Piston pump BSA
- + TII Delivery line
- + E Stationary placing boom MX



Solution concept
with scissor pipes

Automated solution for precast parts in housing construction. The operator controls the entire plant via radio remote control.

Combination example #3

- + H Buffer storage
- + TI Piston pump BSA
- + TII Delivery line
- + E Scissor pipe

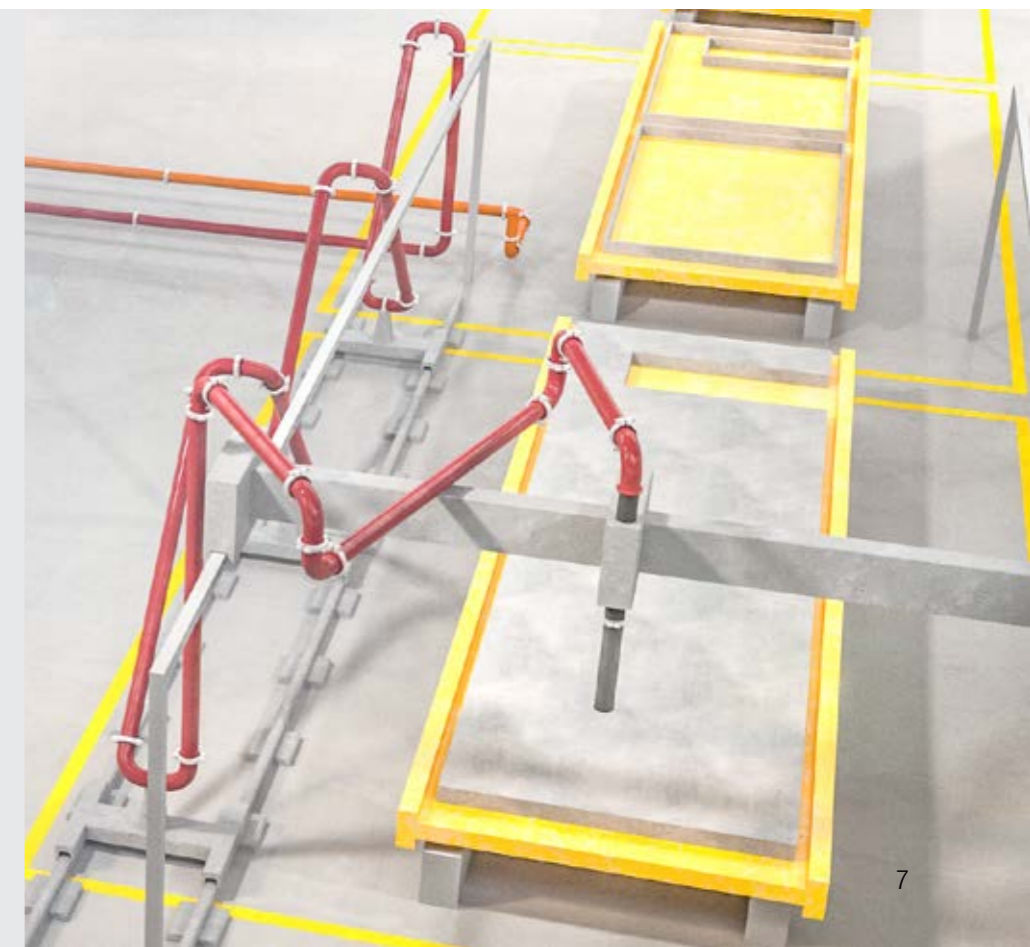

Our solutions in action – efficiency is demonstrated on a daily basis

Full capacity with minimum noise and emissions

Large components manufactured in cycles A combination of concrete pump from the BSA series and a RV distribution system is used both for filling ceiling and wall formworks in circulation systems and for the manufacture of large precast parts such as bridge elements and similar. To use these inside factory buildings, they need to run quietly and economically, and should not occupy too much space. The BSA ranges with electric drive are the best choice here. In conjunction with larger rotary distributors and/or hydraulically controlled placing booms, this solution offers optimum combination options.



Large components manufactured in cycles

Smooth logistics is essential for large-scale projects. Precast part plants are often set up temporarily beside the construction site. Putzmeister components are also used there in order to manufacture the necessary components on time and at a high quality.

"With this system we are very productive despite staff shortages. Our future lies in times of an intensifying labour shortage."



Our solutions in action – efficiency and quality always convince

The use of a buffer storage offers several advantages

In the buffer storage several batches of concrete are homogenised. It supplies the concrete pump continuously with concrete and thus meets the requirements that formworks can be filled with concrete quickly and efficiently.



Computer-controlled placement

The usefulness of the modular system is revealed in the manufacture of tower segments for wind turbines. In order to avoid cold joints, the placing boom moves into the formwork and fills it continuously with concrete. The EBC control system ensures that the operator moves the placing boom up with only one joystick.

"This means that we can work on several formworks at the same time, increased our productivity by around 60%, with reduced process costs!"

"The Putzmeister solution offers better utilisation of the operating equipment, the area and above all the crane, which is available for other applications."



Proven individual components for the modular principle



Concrete production – buffer storage



Optimal interaction of components

Precast concrete parts can be manufactured very economically indeed using the Putzmeister Autocor® modular system involving tried-and-tested products and control units. Stationary concrete pump, delivery lines and boom form a single unit, which ensures increased productivity, quality and cleanliness in processes in the manufacture of concrete parts.



ergonic
inside

Ergonic® 2.0 – intelligent control

If the components are the organs of your system, then Ergonic® 2.0 is the head. Ergonic® inside – this is the optimised computer-aided control system of the concrete pump, placing boom and buffer storage. How do you benefit? Your system is ready for use more quickly, you achieve higher performances and work with minimal wear as well as in fuel-saving mode.

Comfortable to operate from any (work) station

Using the ergonomically positioned radio remote control, several movements can be performed at the same time with actual two-handed operation and without changing hand position. All the machine data of the pump appears on the EGD (Ergonic® Graphic Display), allowing the machine operator to continuously monitor all parameters



(Almost) indispensable: The buffer storage

Individually adapted to your production, hopper extensions (with low delivery rates), jumbo troughs or mixer drums serve as buffer storage.

They are all distinguished by the use of components which are particularly maintenance-friendly and wear-free. The mixer drums, for example, are manufactured from high-strength special steel and provided with end-to-end welded-on wear protection on the mixer coils.

The drum geometry allows quick unloading with optimum mixing efficiency and maximum loading capacity. Different batches are homogenised, thus increasing the quality of the concrete.



The buffer storage can be placed directly under the mixing plant or can be filled via an existing bucket conveyor.

For small precast parts or small mixing plants a hopper extension is enough to guarantee the continuous supply of the concrete pump with concrete.

Smooth running, not only at the placing boom

In addition, the EBC system, which has been tried and tested for years with Putzmeister truck-mounted concrete pumps, ensures that the concrete placing boom remains level during all manoeuvres, e.g. when moving and rotating – even at a high output. At the same time, if required, the working area of the boom can be limited in order to prevent collisions with ceiling beams or other obstacles in the room, for example.

Squeeze valve prevents spills

The end hose is squeezed together when you wish to interrupt or stop the flow of concrete. This is done with such force that dripping is completely eliminated.





Concrete transport I – rotor pumps and stationary pumps

Robust and quiet – the rotor pump

One of the greatest strengths of this pump is that it works with an extremely low level of noise because of its smooth running, which is due to the computer-aided control system (Ergonic®), among other things. Another key

characteristic is the extremely low wear of the pump components. The rotor pump is ideally suited for pumping every type of pumpable concrete, self-compacting concrete and lightweight concrete. Thanks to its

efficient agitator, it is robust and undemanding to use. Slants in the hopper bottom as well as a rotor inclined to the horizontal ensure that the concrete in the hopper can be used almost completely.

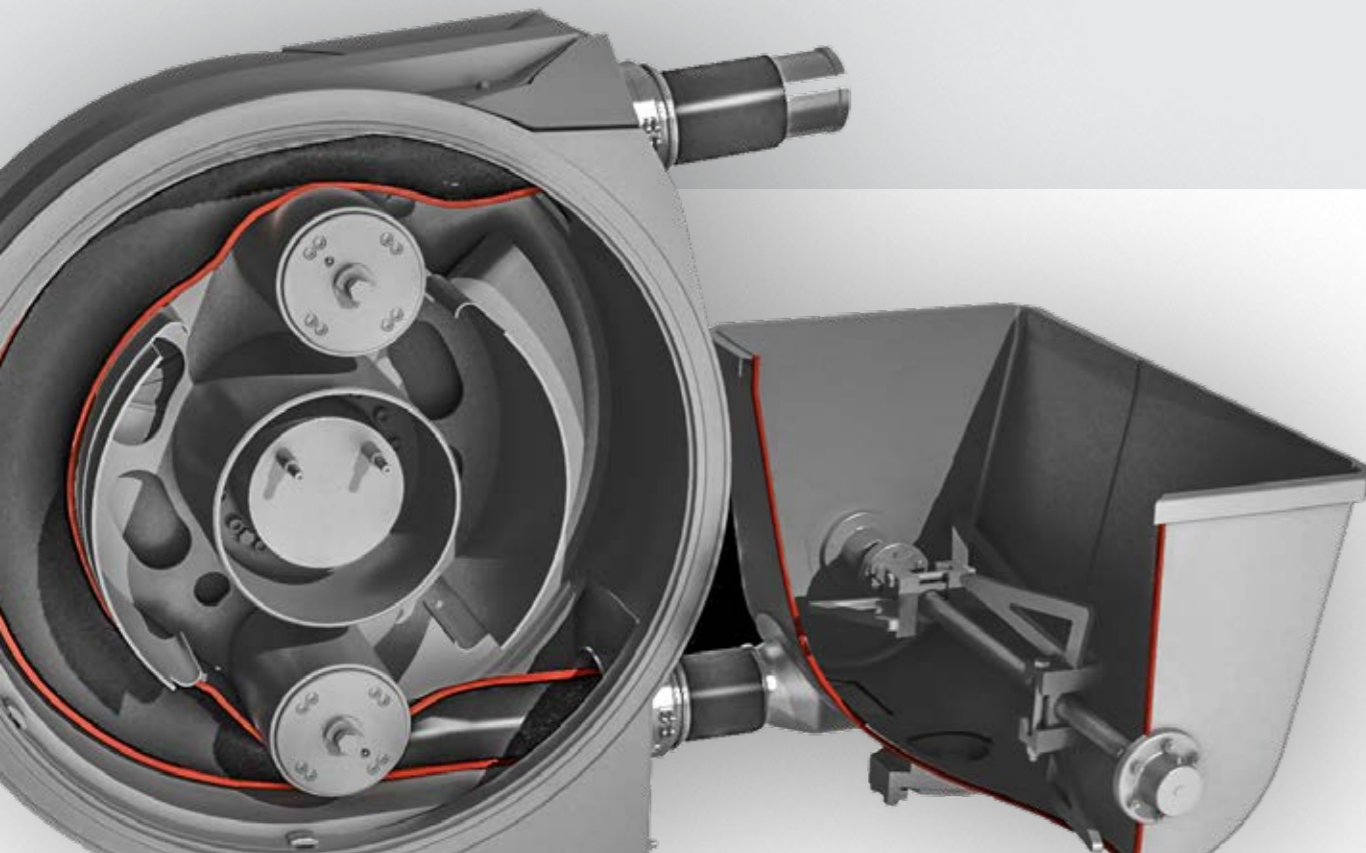

Advantages of the rotor pump

- **Quick and easy cleaning**
- **Almost no concrete residue**
- **Reduced wear** as the rotor hose is the only wear part
- **Vacuum in the rotor housing** supports the rotor hose
- **Suitable for pumpable normal concrete, self-compacting concrete and lightweight concrete**
- **Quiet pumping process**
- **Infinitely adjustable output** from 0 to 40 m³/h
- **Series standard Ergonic® systems**
- **Ideal for smaller factories** which use a daily concrete volume of up to approx. 40 m³
- **Extremely quiet** in operation
- **Optional with active cooling** for use in warmer climate zones

Stationary concrete pumps – the powerful, durable and reliable long-distance conveyor

What makes stationary concrete pumps from Putzmeister extremely efficient? The perfect coordination of individual components such as drive, long-stroke piston pump, free-flow hydraulics, S transfer tubes and the electronic EPS control system (Ergonic® Pump System). This ensures maximum pump capacity and very smooth running.

The BSA series with electric drive is the best choice for precast part plants because they are extremely low-noise. They are also available with environmentally friendly diesel engines for temporary precast part plants. Our comprehensive range offers the right performance for your application.

Benefits of stationary concrete pumps

- **Ideal for medium and large factories with a quantity of up to 100 m³**
- **Ideal for longer distances**
- **For all types of concrete, particularly high-strength and steel fibre concrete**
- **Small installation area**
- **Comprehensive standard equipment and functional accessories**
- **Choice of different low-noise electric motors with varying power levels**



Base your decision on performance

	1005 E	1405 E	1408 E	2109 H E	BQ 06
Output up to	48 m³/h	55 m³/h	79 m³/h	85 m³/h	40 m³/h
Concrete pressure up to	70 bar	106 bar	106 bar	152 bar	25 bar
Drive	45 kW (electric)	75 kW (electric)	110 kW (electric)	160 kW (electric)	45 kW (electric)
Delivery cylinder Ø	180 mm	200 mm	200 mm	200 mm	-
Piston stroke	1 000 mm	1 400 mm	1 400 mm	21 000 mm	-
Weight	2 900 kg	4 600 kg	4 600 kg	6 600 kg	3 400 kg
Pump type	S-tube	S-tube	S-tube	S-tube	Rotor



Concrete transport II – lines, diversion and gate valves

Diversity needs variants – the right line for your job

Requirements of delivery lines vary depending on the medium, pump and delivery pressures. Putzmeister stocks delivery lines from the SK and PX-Ultraflex® series.

SK delivery lines are characterised by flexibility, rotation of the lines at the coupling points and a possible deflection in the longitudinal direction of up to 2°. It is best to combine extension lines, especially those with hoses, with the particularly flexible PX Ultraflex® system.



Diversion and gate valves

The GV gate valves in the M series lock manually, whereas the H series work hydraulically. DVH diversion valves make it possible to load from one concrete pump from several concreting points and to clean the pipeline after concreting.

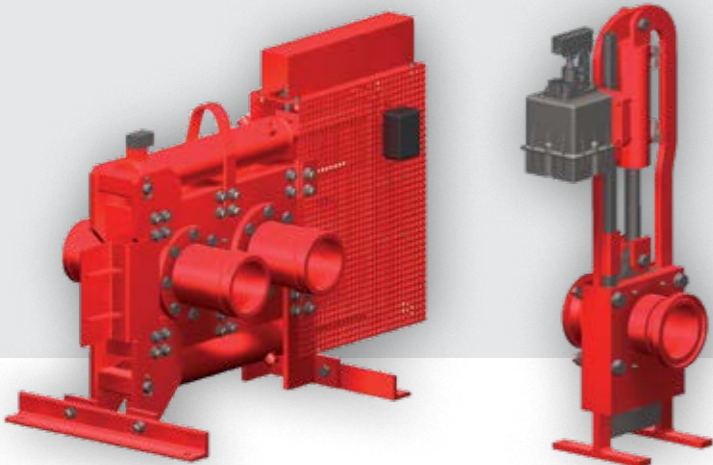

Concrete placement – distributor systems

Filling with rotary distributors – same level

If formworks of equal height need to be filled, rotary distributors are the first choice. The height of the rotary distributor can be individually defined. If fitted on our RS 850 tubular column system, the distributor requires a floor area of only 1 m².

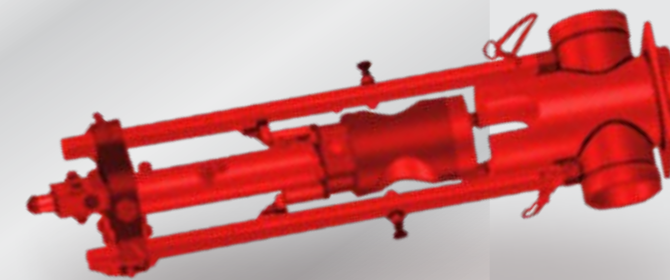

Filling with formwork filler necks – filling formworks from below

Complicated formwork geometries can be easily filled with self-compacting concrete from below.

Filling with placing boom – different levels

Placing booms make it possible to fill formworks without having to extensively reinforce them beforehand. Ranges from 24 m to 35 m are possible – fitted stationary or on tubular columns in the hall. The comprehensive modular programme of the MX stationary booms makes available different ranges on the Putzmeister tubular column system RS-850.



For precast part systems you can rely on Putzmeister – service, parts, training

Everything that sets service apart

Swift assistance, meaningful advice and a reliable supply of genuine Putzmeister accessories and parts - in over 120 countries worldwide. This is what we at Putzmeister understand as first-class service.

Ideally placed to support you

We train our service technicians continuously, provide a close-knit information network and the latest equipment and consistently strive to meet our customers' needs.

Thanks to state-of-the-art technology, our employees have all the relevant technical information about your machine at their fingertips, should the need arise. Allowing us to provide you with the best possible support for emergencies, repairs or preventive maintenance.



Genuine parts for maximum availability

It goes without saying that we use only genuine Putzmeister parts in our workshops. This is the only way to guarantee consistent quality, checked for interoperability. And you can be absolutely sure that your machine meets the tough requirements with maximum performance and availability.

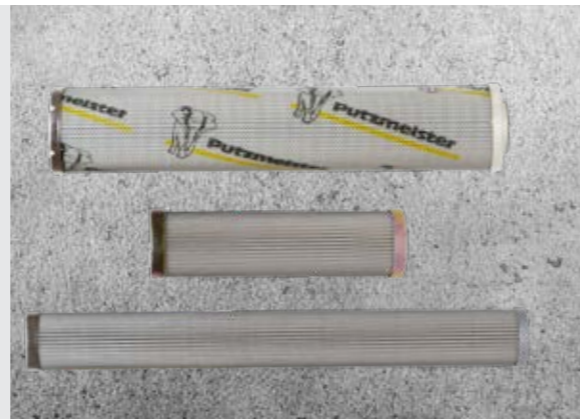

Excellent customer proximity and superb advice

We are there for you from the plant design to the accessories.

Decades of experience, sound know-how on all processes in concrete delivery and innovation make us competent advisors. Rely on our planning support for small or large-scale projects, for existing or imminent production and for all issues relating to concreting logistics and concrete technology.

Your Putzmeister project engineers



Induction at handover – everything correct from the outset

So you and your machinist can adapt perfectly to all special features and innovations.

Customer training – benefit from expert knowledge

Practice-oriented learning offers many benefits: Your staff master the machine with all its special features, use the machine to optimum effect, reduce operating costs and avoid operating errors.

Our services for cost-effective work

The Putzmeister service support points offer you these services - all provided by our experienced service staff:

100 hours of customer service – avoid potential sources of error

With this customer service you receive a status report on your concrete pump as per the Putzmeister service plan.

Mandatory machine inspection – calculable costs instead of incalculable failures

Visual inspection and functional check of components for 100 % safety. The hydraulic system with cylinders, electrical system and core pump are also inspected.

500 hours of customer service – protect your investment, retain your value

Our technical customer service team is the number one choice for checking the safety and wear of your machine. You receive a status report for this, too.

Our range of training courses and seminars:

For concrete pump operators

- Training and development seminars on concrete pumps
- Training and development seminars on PUMI with piston and rotor pumps
- Regional/company seminars (in your region or on your premises)

For concrete pump mechanics

- Training and development seminars on concrete pump

For concrete pump machinists and mechanics

- Practical days in Aichtal
- Training: Handover and induction, on-the-job training

For workshop managers and foremen

- Overview of current developments in Putzmeister concrete pumps
- Qualification at the customer workshops for requisite maintenance work

Further information can be found at: www.pm-akademie.de

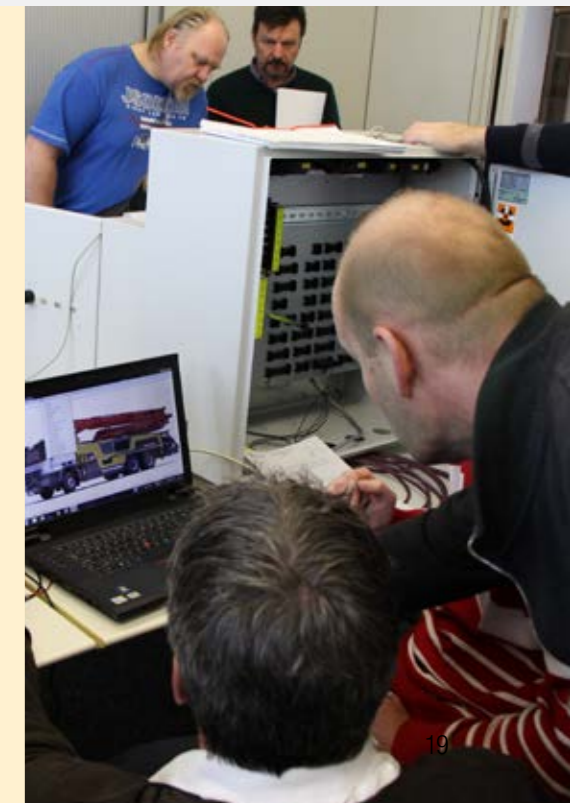

The benefits at a glance

- Flexible systems for the manufacture of diverse precast parts
- Suitable for pumpable normal concrete, high-strength or self-compacting concrete
- Free hall crane capacities can be used elsewhere
- Increases the production volume by up to 60 %
- Higher quality of parts thanks to continuous concrete placement
- Cleaner process thanks to closed system
- No expensive and time-consuming lining of the formwork thanks to flexible boom
- Mobile and stationary concepts
- Formwork can be filled from top or bottom
- Space-saving
- Automated processes with low manpower deployment
- Flexible pipeline construction

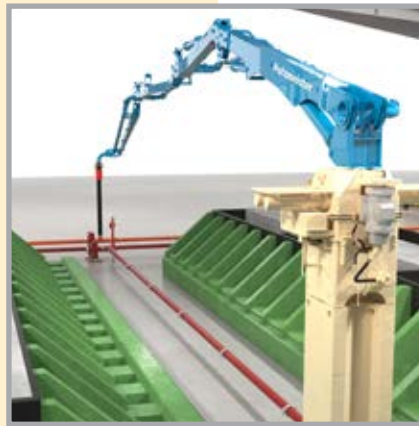
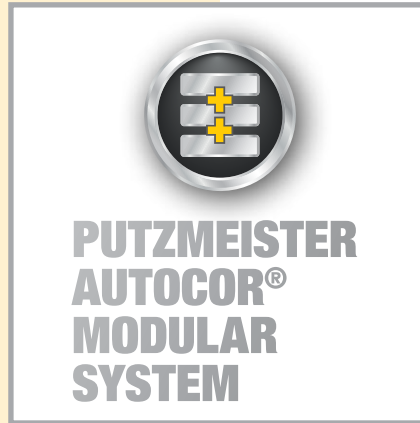

Putzmeister Concrete Pumps GmbH

Max-Eyth-Straße 10 · 72631 Aichtal / Germany
P.O.Box 2152 · 72629 Aichtal / Germany
Tel. +49 (7127) 599-0 · Fax +49 (7127) 599-520
pmw@putzmeister.com · www.putzmeister.com

